

Article number: 390204402072836

Description: Worm Gear with Torque Limiter
VF 44-L2-P-20-P71B14

Measures

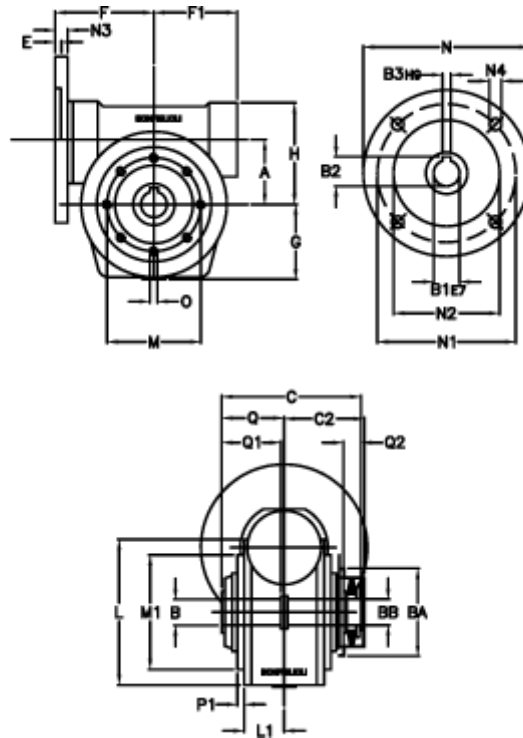

a = 44.60	C2 = 48	L1 = 35.0	O = M6x8
B = 18	Description = VF 44P-xx-71B14	m = 65	P1 = 2.0
B1 E7 = 14	E = 2.0	M1 = 50	Q = 32.0
B2 = 16.3	F = 65	N = 105	Q1 = 32
B3 H9 = 5	F1 = 54	N1 = 85	Q2 = 12
BA = 40	g = 51	N2 = 70	
BB H7 = 11	H = 71.0	N3 = 10.0	
C = 79	L = 80.0	N4 = 7	